

Classic Instruments

Installation Manual

Table of Contents

<i>Speedometer Installation</i>	1
<i>Speedometer Wiring</i>	1
Optional Pulse Signal Generator [SN16] Wiring	2
Ford Signal Generator Adapter [SN17]	2
<i>Speedometer Calibration</i>	4
Entering Calibration Mode:	4
Speedometer “Instant” Calibration:	5
Speedometer “Real-Time” Calibration:.....	6
Speedometer “Measured Mile/Kilometer” Calibration:	7
Reset Gauge Calibration to Factory Defaults:.....	7
<i>Tachometer Installation</i>	8
<i>Tachometer Wiring</i>	8
<i>Tachometer Setup</i>	10
Set Signal Type	10
Set # of Cylinder Signal Type.....	10
Optional: Set Shift Light Trigger Point	10
<i>2 1/8” Gauge Installation</i>	11
<i>2 1/8” Gauge Wiring</i>	11
<i>Quad Cluster Installation</i>	12
<i>Quad Cluster Wiring</i>	12
<i>3 3/8” Dual Cluster Installation</i>	14
<i>3 3/8” Dual Temperature & Volt Cluster Wiring</i>	14
<i>3 3/8” Dual Fuel & Oil Pressure Cluster Wiring</i>	14
<i>Oil Pressure Sender Installation</i>	16
<i>Temperature Sender Installation</i>	17
VW Oil Temperature Sensor Kit.....	18
Oil Pan Temperature Sensor	18
Transmission Temperature Sensor.....	18
<i>Tachometer Troubleshooting</i>	19
<i>Oil Pressure Troubleshooting</i>	19
<i>Fuel Level Sender/Gauge Troubleshooting</i>	20
<i>Temperature Troubleshooting</i>	21
<i>Battery Volts Troubleshooting</i>	22
<i>Speedometer Troubleshooting</i>	23

Welcome from the Team of Classic Instruments!

Our congratulations and appreciation for your purchase of one of the finest quality sets of specialty instruments ever produced! Your instrument set has been conceived, designed, and manufactured by Classic Instruments, Inc. in the U.S.A. Each instrument has been tested and certified for accuracy and quality before packaging and shipping.

For trouble-free installation and operation follow the instructions exactly as outlined. Your instruments were assembled to precise specifications and although each has a seven (7) year warranty covering defective parts and workmanship – this warranty will not cover instruments or sender units which have been installed incorrectly.

Follow our recommended procedures for installation and proper hookup to maintain the value and appearance of your instrument set during many future years of accurate and dependable service!

SPECIAL NOTES:

Due to rapid changes in technology, some instruments may not be included in this manual. In this situation please refer to special instruction sheets and stickers located on your instrument. Recommended dash hole sizes are 2 1/8", 3 3/8" or 4 5/8" for front mounting our gauges. Please call us at 1-800-575-0461 with any questions.

LIMITED WARRANTY

Classic Instruments, Inc. (CI) warrants to the original purchaser that any CI product manufactured or supplied by CI will be free from defects in material and workmanship under normal use and service for a period of seven (7) years from date of purchase.

Improper installation, use of sending units other than CI's or attempted repair or adjustments by other than CI shall void this warranty. Disassembly of any instruments or senders for whatever reason shall specifically void this warranty.

It's always easy to look to a part for an issue with your set. Before you conclude that a part may be bad, thoroughly check your work. Today's semiconductors and passive components have reached incredibly high reliability levels, but there is still room for error in our human construction skills. However, on rare occasions a sour part can slip through. Please be aware that testing can usually determine if the part was truly defective or damaged by assembly or usage. Don't be afraid of telling us that you "blew it", we're all human and in most cases, replacement parts are very reasonably priced.

Purchaser requesting a product to be repaired or replaced under warranty must first call CI at 1-800-575-0461 before the return of defective part. Send defective part to 826 Moll Drive, Boyne City, MI 49712, USA. Include a written description of the failure with defective part.

Purchaser agrees and accepts that under no circumstances will a warranty replacement be furnished until CI has first received, inspected, and tested the returned part.

All other warranties expressed or implied are hereby excluded including any implied warranty of merchandise and implied warranty of fitness for a particular purpose. The sole and exclusive remedy for breach of this warranty is limited to the replacement set forth above.

It is expressly agreed that there shall be no further remedy for consequential or other type of damage, including any claim for loss of profit, engine damage or injury.

TECHNICAL ASSISTANCE

1-800-575-0461

OR

Visit our new website for the latest in gauge design and updates to our installation manual at:

www.classicinstruments.com

Speedometer Installation

- 1) Make sure you have sufficient clearance (3 ½”) behind the panel where you intend to mount the speedometer.
- 2) If necessary, cut a 3.375” hole or 4.625” hole (depending on which speedometer you have) in the dash panel at the desired location.
- 3) Fit the mounting bracket over the mounting studs of the speedometer. The legs of the bracket may be shortened if required.

Speedometer Wiring

- 1) Always disconnect the ground lead from the vehicle battery before wiring any gauge.
- 2) Connect a switched +12VDC power source to the **Pink** wire of the gauge harness. *We recommend using a dedicated power source for the speedometer to avoid possible problems caused by interference.*
- 3) Connect a good chassis ground to the **Black** wire of the gauge harness. *We recommend using a dedicated chassis ground (not stacked with other ground wires) to avoid possible problems caused by a bad ground.*
- 4) Connect dash light power to the **Grey** wire of the gauge harness.
- 5) Connect a speed signal to the **Purple** wire of the gauge harness:
 - a. White signal wire from a Classic Instruments pulse signal generator (*SN16 or SN16F*)
 - i. *Connect the Black wire of the pulse signal generator to a good chassis ground.*
 - ii. *Connect the Red wire of the pulse signal generator to the **Red** wire of the gauge harness.*[OR]
 - b. One (either) wire of an electronic transmission’s 2-wire vehicle speed sensor [VSS].
 - i. *Connect the other VSS wire to the same ground used for the gauge.*[OR]
 - c. Speedometer Signal wire of the vehicle computer [PCM].
 - i. Set the Filter Switch on the back of the speedometer to ON.
- 6) Connect one wire of the speedometer calibration button to the **Brown** wire of the gauge harness.
 - a. Connect the other wire of the calibration button to a good chassis ground.
- 7) *Optional:* Connect right turn indicator power to the **Purple / White** wire of the gauge harness.
- 8) *Optional:* Connect high beam indicator power to the **Lt. Green** wire of the gauge harness.
- 9) *Optional:* Connect left turn indicator power to the **Blue / White** wire of the gauge harness.
- 10) The **Blue, White** and **Yellow** wires of the harness are NOT USED.

Optional Pulse Signal Generator [SN16] Wiring

Attach the signal generator to the transmission speedometer gear housing (where the speedometer cable originally connected). Do not use excessive force to tighten. These signal generators produce approximately 16,000 pulses per mile (PPM).

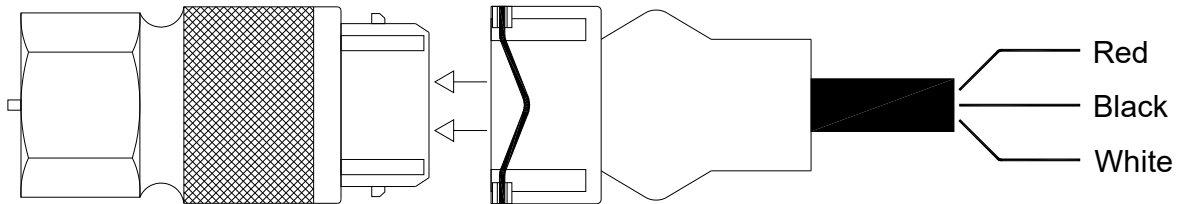

Red: Power (to *Red* wire of the speedometer harness)

Black: Ground (to good chassis ground)

White: Signal (to *Purple* wire of the speedometer harness)

Ford Signal Generator Adapter [SN17]

The SN17 adapter allows the SN16 signal generator to be used on a Ford or Tremec transmission with a cable speedometer drive.

Slide a speedometer driven gear onto the end of the adapter and retain with a snap ring (not provided with sender). The number of teeth on the gear does not matter since all Classic Instruments speedometers are able to be calibrated electronically. Make sure the gear spins freely on the adapter (*with SN16 already attached*) before installing into the transmission.

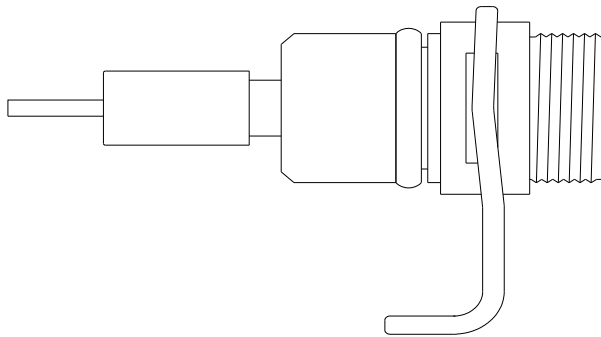

SN17 Transmission Adapter

3 3/8" Speedometer Wiring

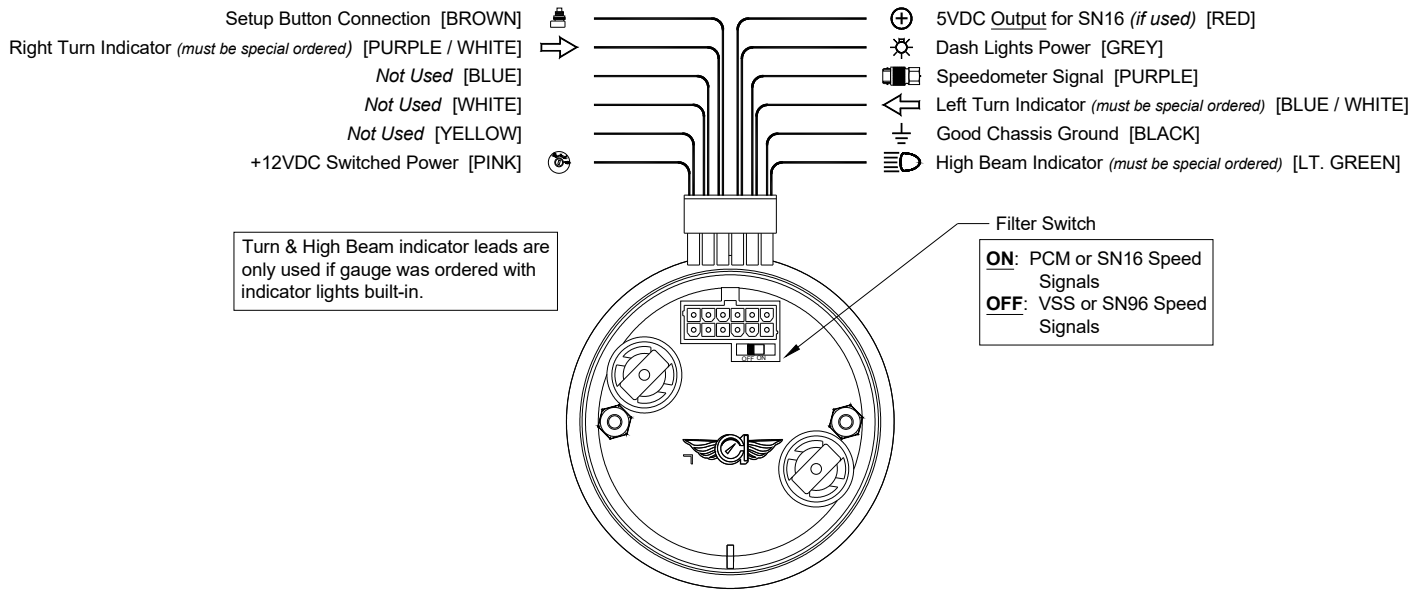

4 5/8" Speedometer Wiring

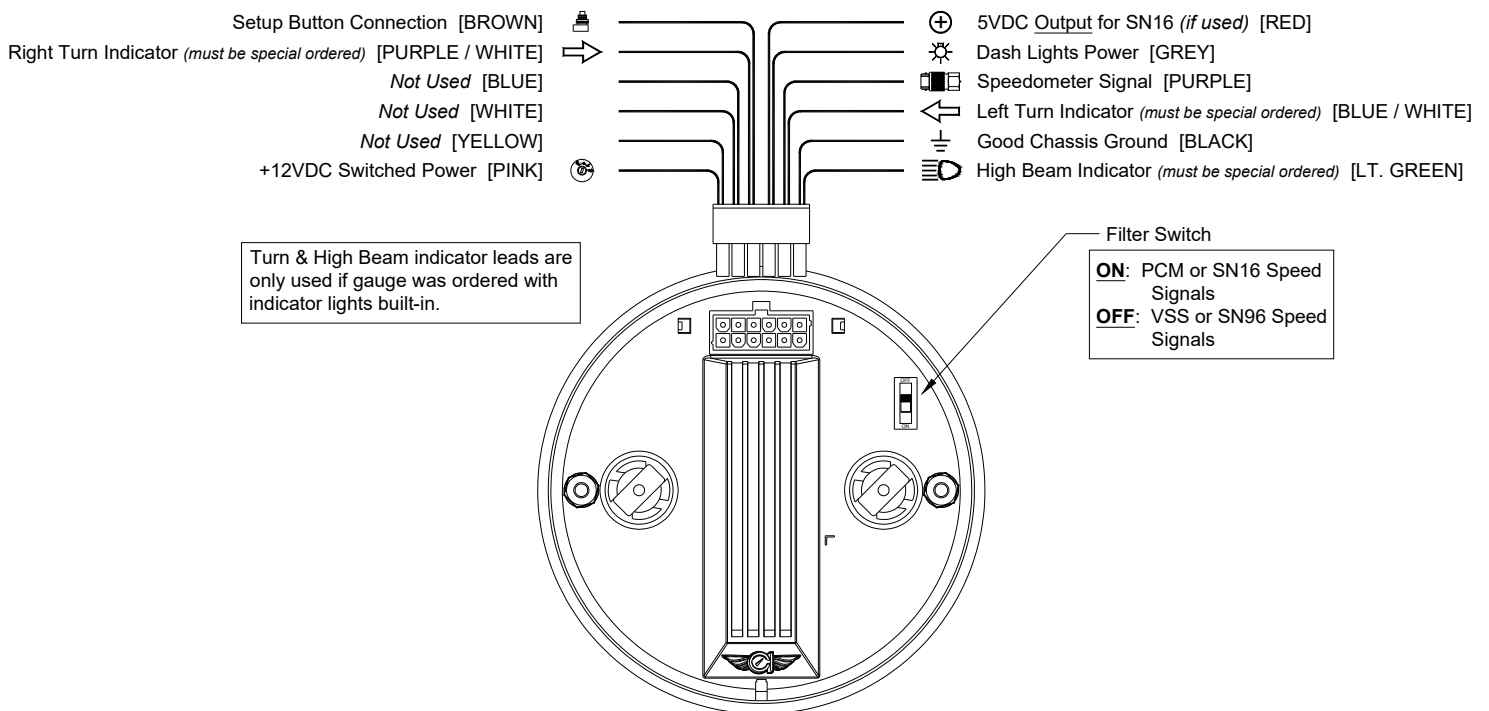

Speedometer Calibration

Note: Before performing speedometer calibration, insure you have a good speed signal. Take a test drive and make sure the speedometer shows a speed (even though it may not be correct)! If the speedometer doesn't show a speed, troubleshoot the speed signal before attempting to calibrate the speedometer.

Only one calibration method is necessary to perform to calibrate the speedometer. Pick the method that works best for you.

- The “Instant” calibration method requires a GPS reference speed signal (or pace car). You will need to drive at 30(mph/kph). This method is convenient if the speedometer is more than 10(mph/kph) off at a known 60(mph/kph).
- The “Real-time” calibration method requires a GPS reference speed signal (or pace car). This method allows you to drive at any known speed and make changes to the speedometer reading as you go. This method is best used if the speedometer calibration is less than 10(mph/kph) off at a known 60(mph/kph).
- The “Measured (Mile/ Kilometer)” calibration method requires you to drive a known mile/kilometer. This is convenient when a GPS is not available to use as a reference and also if the calibration is off more than 10(mph/kph) at a known 60(mph/kph). The speed at which you drive the known mile can be varied, a GPS reference or pace car is not necessary.

Calibration Modes	
Speedometer Indication	Calibration Mode
50 MPH/KPH	Speedometer “Instant” Calibration
60 MPH/KPH	Speedometer “Real-time” Calibration
70 MPH/KPH	Speedometer “Measured Mile/Kilometer” Calibration
80 MPH/KPH	Factory Defaults Reset Mode
90 MPH/KPH	Exit calibration Mode

Entering Calibration Mode:

- 1) Start with power to the gauge OFF.
 - 2) Press and HOLD the calibration pushbutton.
 - 3) Start engine.
 - 4) Release the pushbutton after the engine is started. The speedometer will indicate 50 MPH/KPH.
-

Speedometer “Instant” Calibration:

(steps 1-4 may be skipped if the gauge is already in calibration mode)

- 1) Start with power to the gauge OFF.
- 2) Press and HOLD the calibration pushbutton.
- 3) Start engine.
- 4) Release the pushbutton after the engine is started. The speedometer will indicate 50 MPH/KPH.
- 5) With the speedometer indicating 50 MPH/KPH, press and hold the calibration pushbutton until the speedometer changes to 0 MPH/KPH. *If the speedometer pointer is not at 50 MPH/KPH, tap the button to cycle the pointer through the calibration modes until it comes back to 50 MPH/KPH.*
- 6) Drive the vehicle at exactly 30 MPH/KPH using a GPS or pace car as a reference. Press and hold the pushbutton while traveling 30 MPH/KPH for approximately 4 seconds until the speedometer moves up to 30MPH/KPH. The speedometer will now track your speed. Verify that the speedometer is now reading accurately.
- 7) If you are satisfied with the speedometer calibration, tap the pushbutton to get back to the calibration mode options. If you would like to re-do the calibration, press and hold the pushbutton to restart the Instant Calibration process.
- 8) When you are finished, tap the pushbutton (as many times as needed) to move the speedometer pointer through the calibration modes to get to the 90 MPH/KPH (Exit Calibration Mode) option. With the pointer at 90 MPH/KPH, press and hold the button for about 6 seconds until the speedometer moves down and starts indicating your actual speed. The speedometer calibration is now saved.

Speedometer “Real-Time” Calibration:

(steps 1-4 may be skipped if the gauge is already in calibration mode)

- 1) Start with power to the gauge OFF.
- 2) Press and HOLD the calibration pushbutton.
- 3) Start engine.
- 4) Release the pushbutton after the engine is started. The speedometer will indicate 50 MPH/KPH.
- 5) Tap the calibration pushbutton once to move the speedometer pointer up to 60 MPH/KPH. *If you missed stopping the pointer at 60 MPH/KPH, continue to tap the button to cycle the pointer through the calibration modes until it comes back to 60 MPH/KPH.*
- 6) With the speedometer indicating 60 MPH/KPH, press and hold the calibration pushbutton until the speedometer changes to 0 MPH/KPH.
- 7) Begin driving a known speed using a GPS or pace vehicle as a reference.
- 8) Press and hold the pushbutton to slowly change the indicated speed. The first time the button is pressed will increase the speedometer reading. The next time the button is pressed will decrease the speedometer reading. The speedometer will alternate between increasing and decreasing speed each time the button is pressed and held.
- 9) Continue to press and hold the pushbutton until the speedometer is indicating the correct speed.
- 10) Once the correct speed is dialed in on the speedometer, wait 8 seconds without pressing the pushbutton to have the current calibration saved. *If you still need to adjust the speed after this 8 second timeout, press and hold the button to re-enter the “Real Time” calibration mode again.*
- 11) If you are satisfied with the speedometer calibration, tap the pushbutton (as many times as needed) to move the speedometer pointer through the calibration modes to get to the 90 MPH/KPH (Exit Calibration Mode) option. With the pointer at 90 MPH/KPH, press and hold the button for about 6 seconds until the speedometer moves down and starts indicating your actual speed. The speedometer calibration is now saved.

Speedometer “Measured Mile/Kilometer” Calibration:

(steps 1-4 may be skipped if the gauge is already in calibration mode)

- 1) Start with power to the gauge OFF.
- 2) Press and HOLD the calibration pushbutton.
- 3) Start engine.
- 4) Release the pushbutton after the engine is started. The speedometer will indicate 50 MPH/KPH.
- 5) Tap the calibration pushbutton twice to move the speedometer pointer up to 70 MPH/KPH. *If you missed stopping the pointer at 70 MPH/KPH, continue to tap the button to cycle the pointer through the calibration modes until it comes back to 70 MPH/KPH.*
- 6) With the speedometer indicating 70 MPH/KPH, press and hold the calibration pushbutton until the speedometer changes to 30 MPH/KPH.
- 7) Begin driving a known measured mile/kilometer. *The speed at which you drive does not matter.*
- 8) At the end of the mile/kilometer, press and hold the pushbutton until the speedometer moves from 30MPH/KPH back up to 70 MPH/KPH. *To get a more accurate calibration, stop at the end of the mile/kilometer.*
- 9) If you are satisfied with the speedometer calibration, tap the pushbutton (as many times as needed) to move the speedometer pointer through the calibration modes to get to the 90 MPH/KPH (Exit Calibration Mode) option. With the pointer at 90 MPH/KPH, press and hold the button for about 6 seconds until the speedometer moves down and starts indicating your actual speed. The speedometer calibration is now saved.

Reset Gauge Calibration to Factory Defaults:

(steps 1-4 may be skipped if the gauge is already in calibration mode)

- 1) Start with power to the gauge OFF.
- 2) Press and HOLD the calibration pushbutton.
- 3) Start engine *(or just turn the key ON)*.
- 4) Release the pushbutton after the engine is started *(or the key has been turned ON)*. The speedometer will indicate 50 MPH/KPH.
- 5) Tap the calibration pushbutton three times to move the speedometer pointer up to 80 MPH/KPH. *If you missed stopping the pointer at 80 MPH/KPH, continue to tap the button to cycle the pointer through the calibration modes until it comes back to 80 MPH/KPH.*
- 6) With the speedometer indicating 80 MPH/KPH, press and hold the calibration pushbutton until the speedometer changes to 90 MPH/KPH. The factory speedometer calibration is now set.
- 7) With the speedometer pointer at 90 MPH/KPH, press and hold the button for about 6 seconds until the speedometer pointer moves down to zero.

Tachometer Installation

- 1) Make sure you have sufficient clearance (3 ½”) behind the panel where you intend to mount the tachometer.
- 2) If necessary, cut a 3.375” hole or 4.625” hole (depending on which size tachometer you have) in the dash panel at the desired location.
- 3) Fit the mounting bracket over the mounting studs of the tachometer. The legs of the bracket may be shortened if required.

Tachometer Wiring

- 1) Always disconnect the ground lead from the vehicle battery before wiring any gauge.
- 2) Connect a switched +12VDC power source to the **Pink** wire of the gauge harness.
- 3) Connect a good chassis ground to the **Black** wire of the gauge harness.
- 4) Connect dash light power to the **Grey** wire of the gauge harness.
- 5) Connect one wire of the tachometer calibration button to the **Brown** wire of the gauge harness.
 - a. Connect the other wire of the calibration button to a good chassis ground.
- 6) Optional: Connect a remote shift light indicator’s Ground to the **Yellow / White** wire of the gauge harness.
- 7) Connect tachometer signal to the **White** wire of the gauge harness. Refer to the following list of ignition system types to help determine where to get the signal.

STANDARD POINTS & CONDENSER SYSTEM

Connect the negative side of the coil (usually marked as “-“) to the white wire of the gauge harness.

GMC – HEI (High Energy Ignition System)

Connect the “TACH” terminal on coil side of distributor cap to the white wire of the gauge harness.

MSD (Multiple Spark Discharge System)

Connect the Tach signal on the MSD box to the white wire of the gauge harness.

VERTEX MAGNETO SYSTEM

Connect the “KILL” terminal on the side of a Vertex magneto body to the white wire of the gauge harness.

An external adapter such as an MSD “Pro Mag Tach Converter” #8132 may be required.

ACCEL IGNITION COILS

Connect the negative side of the coil to the white wire of the gauge harness. CAUTION! Some Accel ignition coils require the tach signal wire to be connected to the “+” terminal on the coil! PLEASE carefully read Accel’s instructions before connecting ignition coil.

MALLORY IGNITION

Connect the negative terminal side of coil (usually marked as “-“) to the white wire of the gauge harness.

IMPORTANT! Some Mallory ignition systems may require you to adjust the tachometer at the 4-cylinder setting (rather than the 8-cylinder setting).

ECM TACHOMETER SIGNAL







Connect the signal wire from the ECM to the white wire of the gauge harness. When using this type of signal, you may need to set the tachometer to the 4-cylinder setting regardless of the actual cylinders on the engine. Also, set the signal type to 5V when using this signal.

MULTIPLE COIL IGNITION SYSTEMS

A tach adapter is required for these ignition systems. A tach signal driver such as the MSD #8913, which produces a 12V square wave signal, is recommended along with a SN74Z signal converter. Please check with manufacturer for your specific application.





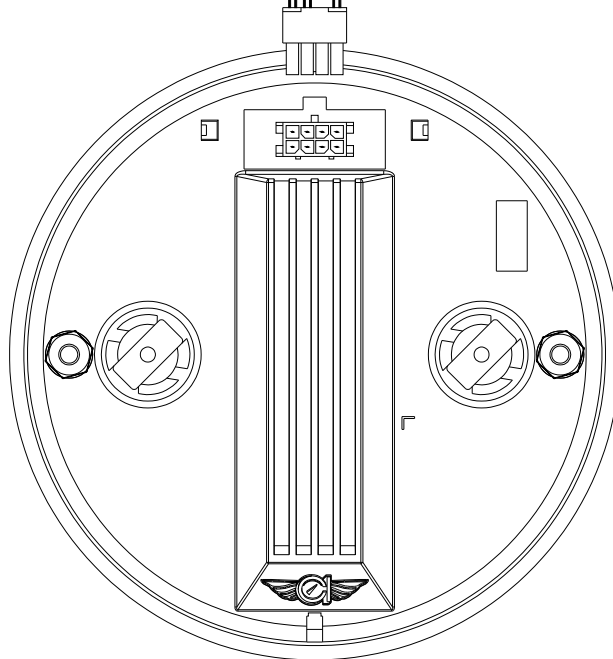

NOTICE! For all other ignition systems please look at the owner’s manual for that system.

4 5/8-Inch Tachometer

- Setup Button Connection [BROWN] 
- Good Chassis Ground [BLACK] 
- Tachometer Signal [WHITE] 
- Shift Light Output [YELLOW / WHITE] 
-  Dash Light Power [GREY]
-  +12VDC Switched Power [PINK]



3 3/8-Inch Tachometer

- Setup Button Connection [BROWN] 
- Good Chassis Ground [BLACK] 
- Tachometer Signal [WHITE] 
- Shift Light Output [YELLOW / WHITE] 
-  Dash Light Power [GREY]
-  +12VDC Switched Power [PINK]

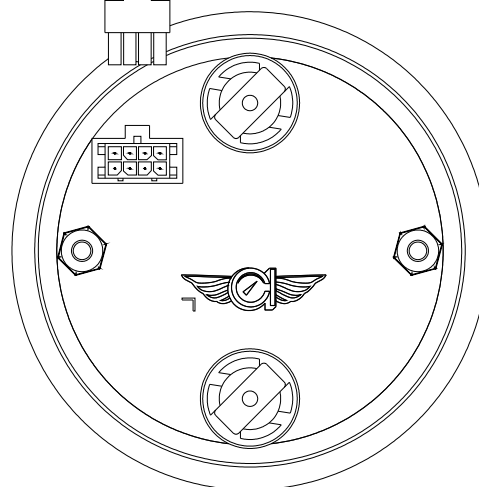

Tachometer Setup

Set Signal Type:

1. Start with power off.
2. Press and hold pushbutton.
3. While pressing pushbutton, apply power to the gauge (starting vehicle not necessary).
4. Release pushbutton once power is applied.
5. Tachometer pointer will indicate 2000 RPM.
6. Press and hold the pushbutton (with tachometer reading 2000 RPM) until the pointer moves to indicate the signal type.
7. Tapping the pushbutton will cause the pointer to alternate between 5000 RPM “Low Voltage Signal” (*from an ECM*) and 6000 RPM “High Voltage Signal” (*from standard, HEI or CDI {MSD} ignitions*).
8. Press and hold the pushbutton until the pointer returns to 0 RPM to save the setting.

Set # of Cylinder Signal Type:

1. Start with power off.
2. Press and hold pushbutton.
3. While pressing pushbutton, apply power to the gauge (starting vehicle not necessary).
4. Release pushbutton once power is applied.
5. Tachometer pointer will indicate 2000 RPM.
6. Tap the pushbutton to index the pointer to 4000 RPM “4-cylinder”, 6000 RPM “6-cylinder” or 8000 RPM “8-cylinder”.
7. Press and hold the pushbutton with the pointer indicating the desired setting (4000, 6000 or 8000) to set the signal type. Once set, the pointer will return to 0 RPM.

Optional: Set Shift Light Trigger Point:

1. Start with power off.
2. Press and hold pushbutton.
3. While pressing pushbutton, apply power to the gauge (starting vehicle not necessary).
4. Release pushbutton once power is applied.
5. Tachometer pointer will indicate 2000 RPM.
6. Tap the pushbutton to index the pointer to 3000 RPM.
7. Press and hold the pushbutton (with tachometer reading 3000 RPM) until the pointer moves to indicate the shift light trigger point.
8. Press and hold the pushbutton to change the RPM shown. The first time the pushbutton is pressed and held, the RPM shown will increase. The second time the pushbutton is pressed and held, the RPM shown will decrease. The RPM shown will alternate between increasing and decreasing each time the pushbutton is pressed.
9. Once the correct RPM shift light trigger point is shown, wait 8 seconds without pushing the pushbutton in order to save the setting. The pointer will return to 0 RPM.

Important: Turn power OFF to save changes

2 1/8" Gauge Installation

- 1) Make sure you have sufficient clearance (2 1/2") behind the panel where you intend to mount the gauge.
- 2) If necessary, cut a 2.125" hole in the dash panel at the desired location.
- 3) Fit the mounting bracket over the mounting studs ("unmarked" and "G") of the gauge. The legs of the bracket may be shortened if required.

2 1/8" Gauge Wiring

- 1) Always disconnect the ground lead from the vehicle battery before wiring any gauge.
- 2) Connect the sender to terminal "S" on the back of the gauge.
 - a. Volt gauge: no sender is required. **DO NOT connect any wire to the "S" terminal of a volt gauge. The "S" terminal has been intentionally removed on most gauges to help prevent damage.**
 - b. Water Temperature gauge: connect the top terminal of a Classic Instruments temperature sender to the "S" terminal on the back of the gauge.
 - c. Oil Pressure gauge: connect the top terminal of a Classic Instruments oil pressure sender to the "S" terminal on the back of the gauge.
 - d. Fuel gauge: connect the top terminal of a Classic Instruments fuel sender (or signal terminal of an OEM fuel sender if matching gauge was ordered) to the "S" terminal on the back of the gauge.
 - e. Transmission Temperature gauge: connect the top terminal of a Classic Instruments temperature sender to the "S" terminal on the back of the gauge.
 - f. Oil Temperature gauge: connect the top terminal of a Classic Instruments temperature sender to the "S" terminal on the back of the gauge.
- 3) Connect a good ground to terminal "G" on the back of the gauge.
- 4) Connect a switched +12VDC power source to terminal "I" on the back of the gauge.
 - a. Use a dedicated 5A fuse to provide power to your gauges.
- 5) Connect dash light power to the spade connector on the back of the gauge.

2 1/8" Fuel, Oil Pressure, Temperature and Volt Gauges

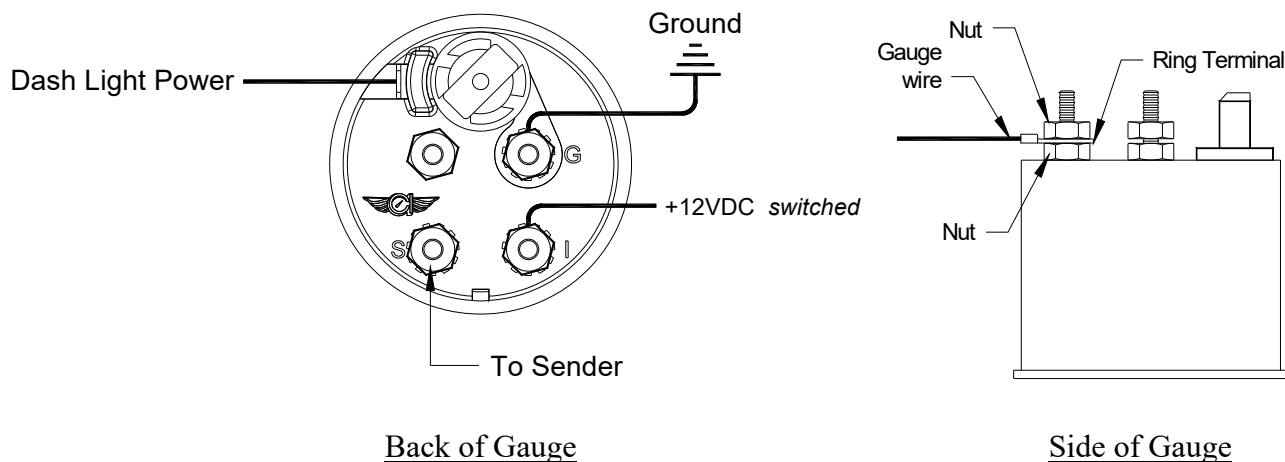

Quad Cluster Installation

- 1) Make sure you have sufficient clearance (3 ½”) behind the panel where you intend to mount the quad cluster.
- 2) If necessary, cut a 3.375” hole or 4.625” hole (depending on which size quad cluster you have) in the dash panel at the desired location.
- 3) Fit the mounting bracket over the mounting studs of the quad cluster. The legs of the bracket may be shortened if required.

Quad Cluster Wiring

- 1) Always disconnect the ground lead from the vehicle battery before wiring any gauge.
- 2) Connect a switched +12VDC power source to the **Pink** wire of the gauge harness.
- 3) Connect a good chassis ground to the **Black** wire of the gauge harness.
- 4) Connect dash light power to the **Grey** wire of the gauge harness.
- 5) Connect a fuel level sender to the **Tan** wire of the gauge harness.
- 6) Connect a Classic Instruments oil pressure sender to the **Blue** wire of the gauge harness.
- 7) Connect a Classic Instruments temperature sender to the **Green** wire of the gauge harness.
- 8) Optional: Connect optional indicator “A” trigger to the **Yellow / Green** wire of the gauge harness.
 - a. NOTE: Indicator only available when special ordered.
- 9) Optional: Connect optional indicator “B” trigger to the **Orange / Green** wire of the gauge harness.
 - a. NOTE: Indicator only available when special ordered.

Wiring diagrams located on the following page

4 5/8" Quad Cluster

Optional Indicator "B" trigger [ORANGE / GREEN]

+12VDC Switched Power [PINK]

Optional Indicator "A" trigger [YELLOW / GREEN]

Fuel Level Signal [TAN]

Temperature Signal [GREEN]

Dash Light Power [GREY]

Oil Pressure Signal [BLUE]

Good Chassis Ground [BLACK]

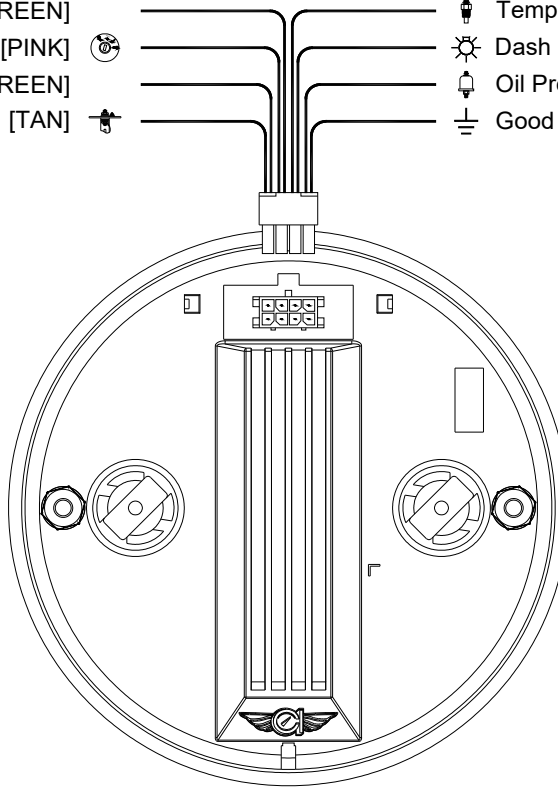

3 3/8" Quad Cluster

Optional Indicator "B" trigger [ORANGE / GREEN]

+12VDC Switched Power [PINK]

Optional Indicator "A" trigger [YELLOW / GREEN]

Fuel Level Signal [TAN]

Temperature Signal [GREEN]

Dash Light Power [GREY]

Oil Pressure Signal [BLUE]

Good Chassis Ground [BLACK]

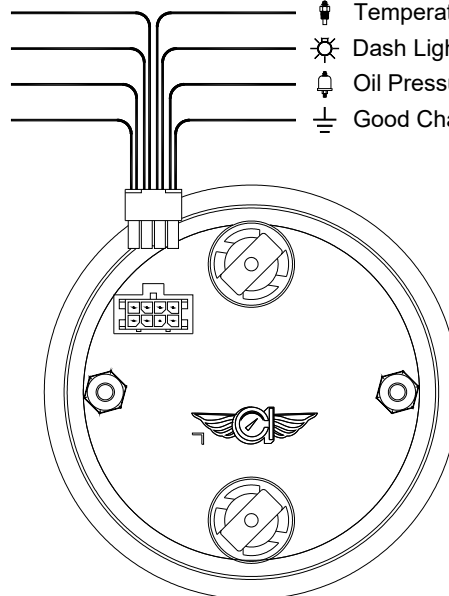

3 3/8" Dual Cluster Installation

- 1) Make sure you have sufficient clearance (3 1/2") behind the panel where you intend to mount the quad cluster.
- 2) If necessary, cut a 3.375" hole in the dash panel at the desired location.
- 3) Fit the mounting brackets over the mounting studs of the dual cluster. The legs of the brackets may be shortened if required.

3 3/8" Dual Temperature & Volt Cluster Wiring

- 1) Always disconnect the ground lead from the vehicle battery before wiring any gauge.
- 2) Connect a switched +12VDC power source to the **Pink** wire of the gauge harness.
- 3) Connect a good chassis ground to the **Black** wire of the gauge harness.
- 4) Connect dash light power to the **Grey** wire of the gauge harness.
- 5) Connect a Classic Instruments temperature sender to the **Green** wire of the gauge harness.
- 6) Optional: Connect optional indicator "A" trigger to the **Yellow / Green** wire of the gauge harness.
 - a. NOTE: Indicator only available when special ordered.
- 7) Optional: Connect optional indicator "B" trigger to the **Orange / Green** wire of the gauge harness.
 - a. NOTE: Indicator only available when special ordered.
- 8) The **Tan** and **Blue** wires are NOT USED.



3 3/8" Dual Fuel & Oil Pressure Cluster Wiring

- 1) Always disconnect the ground lead from the vehicle battery before wiring any gauge.
- 2) Connect a switched +12VDC power source to the **Pink** wire of the gauge harness.
- 3) Connect a good chassis ground to the **Black** wire of the gauge harness.
- 4) Connect dash light power to the **Grey** wire of the gauge harness.
- 5) Connect a fuel level sender to the **Tan** wire of the gauge harness.
- 6) Connect a Classic Instruments oil pressure sender to the **Blue** wire of the gauge harness.
- 7) Optional: Connect optional indicator "A" trigger to the **Yellow / Green** wire of the gauge harness.
 - a. NOTE: Indicator only available when special ordered.
- 8) Optional: Connect optional indicator "B" trigger to the **Orange / Green** wire of the gauge harness.
 - a. NOTE: Indicator only available when special ordered.
- 9) The **Green** wire is NOT USED.

Wiring diagrams located on the following page



3 3/8" Dual Temperature & Volt Cluster

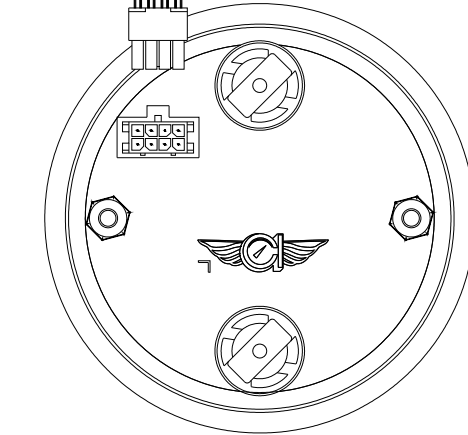

Optional Indicator "B" trigger [ORANGE / GREEN]
 +12VDC Switched Power [PINK] 
Optional Indicator "A" trigger [YELLOW / GREEN]
 Not Used [TAN]

 Temperature Signal [GREEN]
 Dash Light Power [GREY]
 Not Used [BLUE]
 Good Chassis Ground [BLACK]



3 3/8" Dual Fuel & Oil Pressure Cluster

Optional Indicator "B" trigger [ORANGE / GREEN]
 +12VDC Switched Power [PINK] 
Optional Indicator "A" trigger [YELLOW / GREEN]
 Fuel Level Signal [TAN] 

Not Used [GREEN]
 Dash Light Power [GREY]
 Oil Pressure Signal [BLUE]
 Good Chassis Ground [BLACK]

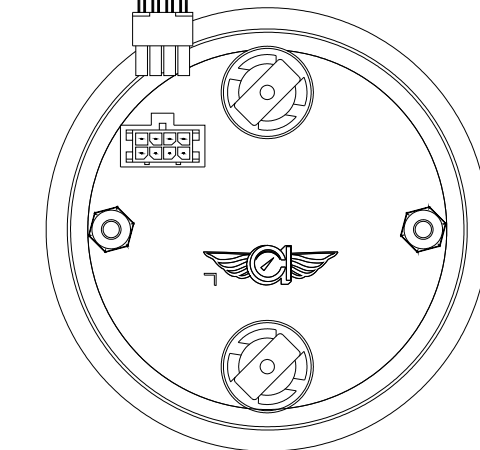

Oil Pressure Sender Installation

(Part No. SN52)

- 1) Disconnect battery before installation.
- 2) Only install Classic Instruments sending units when the engine is COLD.
- 3) DO NOT use Teflon tape on the threads. These threads are slightly tapered and designed to be self-sealing. The sender uses the threads for its ground connection and sealant may cause a poor ground causing inaccurate readings
- 4) Connect a wire from the top terminal of the oil pressure sender to the indicated signal/sensor post or wire on the oil pressure gauge.

GM Installation: The correct location on most GM V8-engines to install the oil pressure sender is under the distributor housing at the rear of the block.

Use the 2 piece bushing kit provided to allow the sender to be mounted at a 45-degree angle pointing towards the driver's knees. This allows the sender to clear the back of the intake manifold, the underside of the distributor housing and also the firewall.

GM Installation – Big Block Engines: Install the sender under the distributor housing at the rear of the engine block. If this location is not available, the oil pressure sender may be installed in the opening located just above the oil filter. This location may not be a full-pressure passage but instead a “by-pass” oil passageway. Installing our pressure sender at this location may result in some strange low-pressure readings under certain driving conditions. This does not indicate a defective instrument or sender! It simply means you need to move the sender to the correct location.

GM Installation – LS Engines: Install the sender in the oil bypass housing located just above the oil filter. The housing will need to be drilled and tapped to 1/8”NPT.

FORD Installation: Install the Classic Instruments oil pressure sender in the Ford V-8 block using the brass bushing kit (all three pieces) provided. These bushings allow the pressure sender to be installed between the motor mount and stock fuel pump. Ford also manufactures a pressure sender extension and if your engine has one of these in place, our brass bushing kit will not be required.

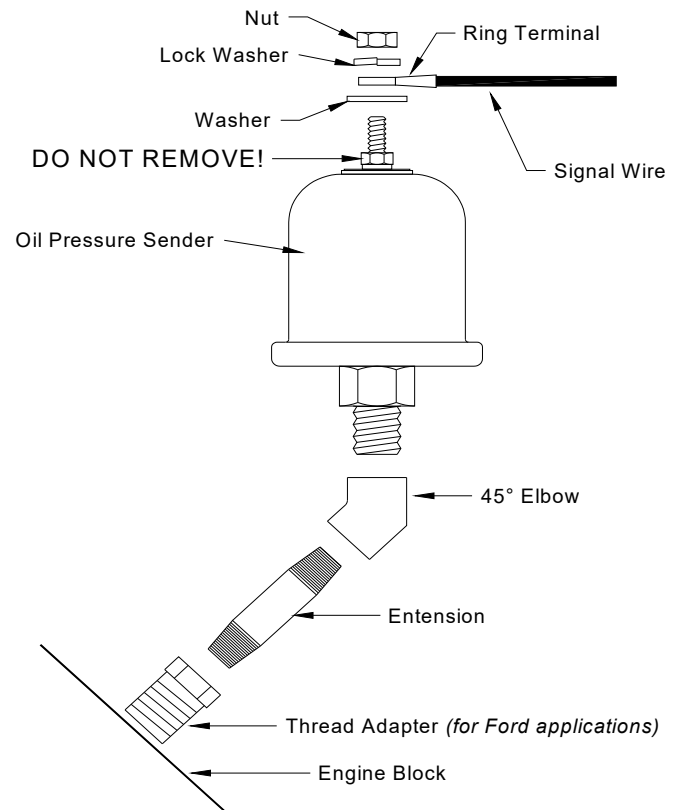

LS1 Oil Bypass Housing

Temperature Sender Installation

(Part No. SN22, SN23, SN12MM, SN24 & SN25)

- 1) Disconnect battery before making any connections.
- 2) Install the Classic Instruments temperature sending unit only when the engine is COLD!
- 3) DO NOT use Teflon tape on the threads. These threads are slightly tapered and designed to be self-sealing. The sender uses the threads for its ground connection and sealant may cause a poor ground causing inaccurate readings
- 4) Install the temperature sender into the intake manifold of your engine as possible. Installing the sender in the engine cylinder head may cause inaccurate temperature readings.
 - a. On GM "LS" engines, the temperature sender mounts on the passenger side of the engine under the rear cylinder. A 12mm thread sender (SN12MM) is available to fit this location.
- 5) Connect a wire from the top terminal of the temperature sender to the indicated signal/sensor post or wire on the temperature gauge.
- 6) Tighten until snug. DO NOT OVER TIGHTEN!

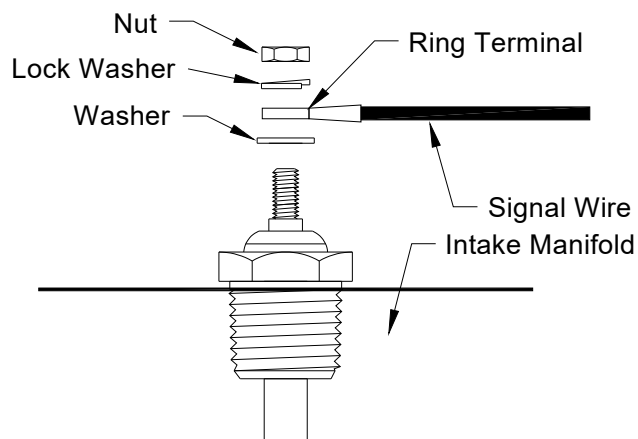

Notice: Avoid installing the temperature sender into the head of a late-model GMC engine. Even though the stock GMC sender may have been installed there, this opening is too close to the exhaust header and will most likely cause an improper reading.

VW Oil Temperature Sensor Kit

VW-type oil temperature sensor kits include sender, metric adapter plug and VW sealing gasket. Install without modification into the oil pressure relief plug opening found on most air-cooled 1960's-type (flat-four air-cooled) VW engines. *Not for installation in the oil-drain plug opening!*

Most VW experts agree the oil pressure relief plug opening in the engine block behind the rear cylinder on the driver's side (U.S. left-hand drive) is a better choice for oil temperature sensor location than installing in the dipstick tube or in the oil pan drain opening.

Oil Pan Temperature Sensor

The temperature of the engine oil in the oil pan can be monitored with our oil temperature sender and gasket. Sender replaces stock drain plug (1/2 – 20 thread) on most GM and Ford engines.

Transmission Temperature Sensor

Classic Instruments recommends monitoring the transmission fluid temperature from the transmission pan. You may need to drill and mount a weld-in bung in your pan to install the temperature sender.

In line transmission temperature manifolds are also available for mounting the temperature sender. However, some transmission companies have stated you may get higher than normal readings if an in-line manifold is used.

Transmission fluid temperature should be kept under 210 degrees. At 230 degrees, the fluid breaks down and the clutches start to glaze resulting in transmission failure.

Tachometer Troubleshooting

Problem: Tachometer showing lower or higher RPM than actual.

Solution: Check cylinder setting on the tachometer. The tachometer is set at 8-cylinder setting from factory. Computer tachometer signals sometimes need the gauge to be set on a 4-cylinder setting.

Problem: Tachometer pointer falls even when maintaining steady engine RPM using a points ignition system.

Solution: Install new points. Check distributor shaft and bearings for wear or play.

Problem: Tachometer pointer stays at 0 even when engine is running.

Solution: Check signal wire for continuity. Insure that you are using correct signal (negative side of coil for points ignitions, “tach” wire on MSD box, “tach” post on HEI distributor, correct signal wire from computer, etc...)

Try using your speed signal with the tachometer (if you know your speedometer is working) to insure the unit will work when given a known good signal.

Oil Pressure Troubleshooting

Problem: Pointer pegs past 100PSI every time power is applied to gauge.

Solution: Make sure sending wire is not being grounded. Removing the sender wire from the gauge should make the pointer move back below 0PSI.

Check the gauge ground. A bad ground will cause the pointer to read high or peg.

Problem: Pointer doesn't show above 0PSI, even when the engine is producing pressure.

Solution: Check continuity on your sender wire. Insure that you have not used Teflon tape on sender. (The pressure sender requires a ground from the engine and Teflon inhibits a good ground.)

Grounding the sender wire should make the gauge read above 100PSI.

Problem: Gauge reads lower than actual pressure.

Solution: Insure that no Teflon tape was used on the pressure sender. A bad sender ground will cause low or no pressure readings on the gauge.

Gauge scale is not linear from 0-25PSI and 75-100PSI. Halfway between 0 and 25PSI is actually 20 PSI, not 12.5PSI if the reading were linear.

Problem: Gauge reads extremely high when engine is idling or not running and drops when engine is revved.

Solution: You may be using an incorrect oil pressure sender. Make sure to use a Classic Instruments oil pressure sender that is a match for the gauge. Some stock GM oil pressure senders will cause a Classic Instruments gauge to read backwards.

Fuel Level Sender/Gauge Troubleshooting

(SN35, SN36, SN38 & SN39)

Identify your fuel gauge: *Refer to sticker on side of gauge.*

Ohm Range	OEM Sender	Gauge Labeled
0-30 ohm	GM 1964 & earlier	0-30
0-90 ohm	GM 1966 & later	0-90
75-10 ohm	Ford 1986 & earlier	75-10
16-158 ohm	Ford 1987 & later	16-158
240-33 ohm	Universal Sender (SN35)	No Label

Problem: **Fuel gauge reads “Full” when powered and the tank is not actually full.**

Solution: *240-33 ohm and 75-10 ohm gauges* → insure sending wire is not being grounded. (Removing sending wire from gauge should cause pointer to peg past Empty) Try a temporary wire from sender to gauge. Ensure that the fuel sender has a good ground.

All other ohm gauges → Check continuity on sending wire. Check if sending wire is attached to correct stud on gauge. (Grounding sending wire on gauge should cause pointer to peg past Empty) Try a temporary wire from sender to gauge.

Problem: **Fuel gauge reads “Empty” no matter how much fuel is in tank.**

Solution: *240-33 ohm and 75-10 ohm gauges* → Check continuity on sending wire. Check if sending wire is attached to correct stud on gauge. (Grounding the sender post on the gauge should cause pointer to peg past Full)

All other ohm gauges → insure sending wire is not being grounded. (Removing sending wire from gauge should cause the pointer to peg past Full) Insure that the fuel sender has a good ground.

Problem: **Pointer shows increasing fuel level when fuel level is actually decreasing.**

Solution: Fuel gauge doesn't match the fuel sender in tank.
Fuel sender rheostat may be mounted upside down in the tank.

Problem: **Pointer stuck somewhere above empty and below full.**

Solution: Fuel sender float arm may be obstructed. Try removing fuel sender and manually moving the float arm.

Check power and ground to gauge. Pointer may not return to empty when power is removed on all fuel gauges.

Temperature Troubleshooting

Problem: **Pointer pegs past “Hot” when power is applied to gauge.**

Solution: Insure that the sender wire is not being grounded. Removing the sending wire from the gauge should cause the pointer to read below “Cold”

Check the ground to the gauge. A bad or no ground on the gauge will cause the gauge to read high or peg to “Hot”.

Problem: **Pointer does not move above “Cold”.**

Solution: Check continuity on the sender wire. Grounding the sending post on the gauge should make the pointer peg past “Hot”.

Insure that no Teflon tape was used on the sender. The sender requires a ground from the engine and Teflon tape creates a bad ground. Try running a ground wire to the base of the temperature sender and see if the gauge starts reading correctly.

Problem: **Gauge reading hotter than actual engine temperature.**

Solution: Insure there is no heat source near the sender (i.e. exhaust) NOTE: Coolant temperature inside the engine will be 15-20 degrees higher than temperatures on the outside of the engine read by laser gauges.

Problem: **Temperature stays constant somewhere above cold and below hot no matter what the heat of the engine.**

Solution: Check power and ground to gauge. Pointer does not always return to cold after power is removed on some models.

Problem: **Gauge reads normal until engine warms up, and then continues to climb past normal reading and coolant isn’t boiling.**

Solution: Insure sender is mounted in correct location. Sender should not be installed on the side of a GMC block, even if original was installed there.

Make sure no thread adapters are used on the sender. A thread adapter will cause an air pocket near the probe of the sender which will be hotter than the engine coolant.

Problem: **Gauge reads low.**

Solution: The temperature gauge reads colder as the resistance to ground of the sender increases. Teflon tape on the threads of the sender could cause the gauge to read more resistance to ground and therefore read colder than the actual temperature. Make sure you don’t have any Teflon tape or sealant on the threads of the sender.

LT1 engines have multiple locations where temperature senders can be mounted. Due to the way the coolant flows through the engine, if you install the sender between the 3 and 5 cylinders your gauge will read 60-80 degrees cold. It is recommended to install the sender either on the head between cylinders 2 and 4 or in the side of the water pump housing.

These symptoms are common in many coolant systems and many result from problems other than outlined above. The following should be checked carefully when at any time an abnormal heating or cooling situation occurs.

1. Slipping belt or incorrect pulley.
2. Incorrect thermostat for system.
3. Distributor spark advanced too far.
4. Wrong coolant/anti-freeze mix.
5. Cross-inductance in wiring harness.
6. High volume water pump installed when not required by total system.
7. Thermostat removed to increase coolant flow, reduced overheating!
8. Insufficient radiator capacity for size of engine and horsepower.
9. Intake manifold has been painted, polished, chrome plated
10. Sender installed too deep and sensor tip is touching other side of passageway.
11. Sender not threaded far enough into manifold; too many threads exposed to allow good “heat-sink” effect from sender.

Our temperature senders will always read the hotter of two adjacent temperatures. Therefore if your sender is installed in a hot spot on the engine such as next to the exhaust pipes on the side of the engine block, the gauge may read as high as 250°F but your radiator seems only mildly warm.

The temperature sender is simply reading the average of two temperatures. For example, your coolant temp is 185°F and your exhaust header temp is 450°F-500°F. The temp sender can only try to read the average of these two temperatures. Therefore your temp reading will appear very high, so please keep the temp sender away from any exhaust manifold/header.

Battery Volts Troubleshooting

Problem: Pointer pegs past 18 volts when key is turned on.

Solution: Make sure the ground wire is on the correct post on the gauge. Insure nothing is touching the sender post.

Problem: Pointer pegs below 8 volts when key is turned on.

Solution: Make sure ground and +12VDC wires are on correct studs.

Speedometer Troubleshooting

Identify your speed signal

Signal Source	Troubleshooting Section
Pulse Generator [SN16 or SN16F]	1
Vehicle Speed Sensor [VSS]	2
Computer [PCM]	3
Sky Drive [GPS]	4

SECTION 1 [SN16]

Speedometer doesn't work at all

Test for power: Make sure the speedometer has 12V on the Pink wire and a good ground on the Black wire. The speedometer pointer will sweep to half scale and back to 0 when power is applied.

Test for signal:

1. With power to the gauge, make sure there is 5V between the pulse generator's Red wire and Black wire.
2. Remove the pulse generator from the transmission and spin its shaft using a drill.
 - 2.1. If the speedometer works, make sure the gear in the transmission is spinning.
 - 2.1.1. If using a SN16F Ford sensor, make sure you have put the gear on the end that goes into the transmission.
 - 2.1.2. If using a SN16, try putting a short ½" piece of 1/8" diameter shrink tube over the end of the pulse generator's shaft. This will make the shaft slightly larger and may make a better connection with the gear in the transmission.
 - 2.2. If the speedometer doesn't work:
 - 2.2.1. Reset the speedometer to factory default and test with drill again.
 - 2.2.2. Disconnect the white signal wire from the speedometer and measure voltage on that wire while spinning the shaft of the sensor.
 - 2.2.2.1. If you get 2.5V when spinning, the sensor is good. Otherwise, the sensor may be bad.

Speedometer works but is erratic

1. Make sure the Red wire of the SN16 is connected to the Red wire of the gauge harness. NO other wires should be connected to these two wires.
2. Turn the filter switch on the back of the speedometer to the ON position.
3. Make sure all connections to the sensor harness are tight.

Speedometer works but is very inaccurate

1. Reset the speedometer to factory defaults.
2. Try calibrating the speedometer with the "Instant Calibration" method and then fine tune if needed with the "Real Time Calibration" method.

SECTION 2 [VSS]

Speedometer doesn't work at all

Test for power: Make sure the speedometer has 12V on the Pink wire and a good ground on the Black wire. The speedometer pointer will sweep to half scale and back to 0 when power is applied.

Test for signal:

1. Remove the signal wires from the gauge and measure AC voltage between those wires.
 - 1.1. When driving, the sensor should produce voltage. The faster you drive, the higher the voltage should go. If you don't get voltages over 1V or no voltage at all, the sensor may be bad.

Speedometer works but is erratic

1. Make sure both wires of the VSS are run up to the speedometer. One of them (either one) needs to be connected to the speedometer's Purple wire and the other connected to the same point where the speedometer's Black wire is grounded.
2. Sometimes it is necessary to run the signal wires in shielded cable to avoid signal interference. Classic Instruments has 10' sections of shielded cable available for purchase.

Speedometer works but is very inaccurate

1. Reset the speedometer to factory defaults.
2. Try calibrating the speedometer with the "Instant Calibration" method and then fine tune if needed with the "Real Time Calibration" method.

SECTION 3 [PCM]

Speedometer doesn't work at all

Test for power: Make sure the speedometer has 12V on the Pink wire and a good ground on the Black wire. The speedometer pointer will sweep to half scale and back to 0 when power is applied.

Test for signal:

1. Remove the signal wire from the gauge and measure DC voltage on the wire coming from the computer.
 - 1.1. When driving, the voltage should be around 2.5V or 6V. When not moving, the voltage should be 0, 5V or 12V. If the voltage doesn't change to 2.5V or 6V when driving, the signal is bad.

Speedometer works but is erratic (especially when at a stop)

1. Turn the filter switch on the back of the speedometer to the ON position.

Speedometer works but is very inaccurate

1. Reset the speedometer to factory defaults.
2. Try calibrating the speedometer with the "Instant Calibration" method and then fine tune if needed with the "Real Time Calibration" method.

SECTION 4 [GPS]

Speedometer doesn't work at all

Test for power: Make sure the speedometer has 12V on the Pink wire and a good ground on the Black wire. The speedometer pointer will sweep to half scale and back to 0 when power is applied.

Test for signal:

1. Remove the signal wire from the gauge and measure DC voltage on the wire coming from the GPS sensor.
 - 1.1. When driving, the voltage should be around 6V. When not moving, the voltage should be 12V. If the voltage doesn't change to 6V when driving, the signal may be bad.

Speedometer works but is erratic (especially when at a stop)

1. Turn the filter switch on the back of the speedometer to the ON position.

Speedometer works but is very inaccurate

1. Reset the speedometer to factory defaults.
2. Perform the calibration routine using the Sky Drive GPS unit. The speedometer calibration will NOT need to be adjusted after the Sky Drive has been set.