

# Speedometer

(With Information Center)

## Installation Manual

# Wiring

- 1) Always disconnect the ground lead from the vehicle battery before wiring any gauge.
- 2) Connect a good chassis ground to the **Black** wire of the gauge harness.
- 3) Connect switched +12VDC power to the **Pink** wire of the gauge harness.
- 4) Connect a speed signal to the **Purple** wire of the gauge harness:
  - a. White wire from a pulse signal generator [SN16]
    - i. Connect the **Red** wire of the SN16 to the **Red** wire of the gauge harness.
    - ii. Connect the **Black** wire of the SN16 to a good chassis ground.
  - [OR]
  - b. One wire (either) of an electronic transmission 2-wire vehicle speed sensor (VSS).
    - i. Connect the other wire of the VSS to the same point as the **Black** wire of the gauge harness.
  - [OR]
  - c. Speedometer signal wire of the vehicle computer (PCM).
    - i. Set the filter switch on the back of the speedometer to ON.
- 5) Connect dash light power to the **Grey** wire of the gauge harness.
- 6) Connect one of the function button's wires to the **Brown** wire of the gauge harness.
  - a. Connect the other function button wire to a good ground.
- 7) Optional connections: *(if ordered with integrated signal lights)*
  - a. Connect high beam indicator power to the **Green** wire of the gauge harness.
  - b. Connect right turn indicator power to the **Purple / White** wire of the gauge harness.
  - c. Connect left turn indicator power to the **Blue / White** wire of the gauge harness.
- 8) The **Blue, White** and **Yellow** wires of the gauge harness are NOT USED.

## 3 3/8" Speedometer

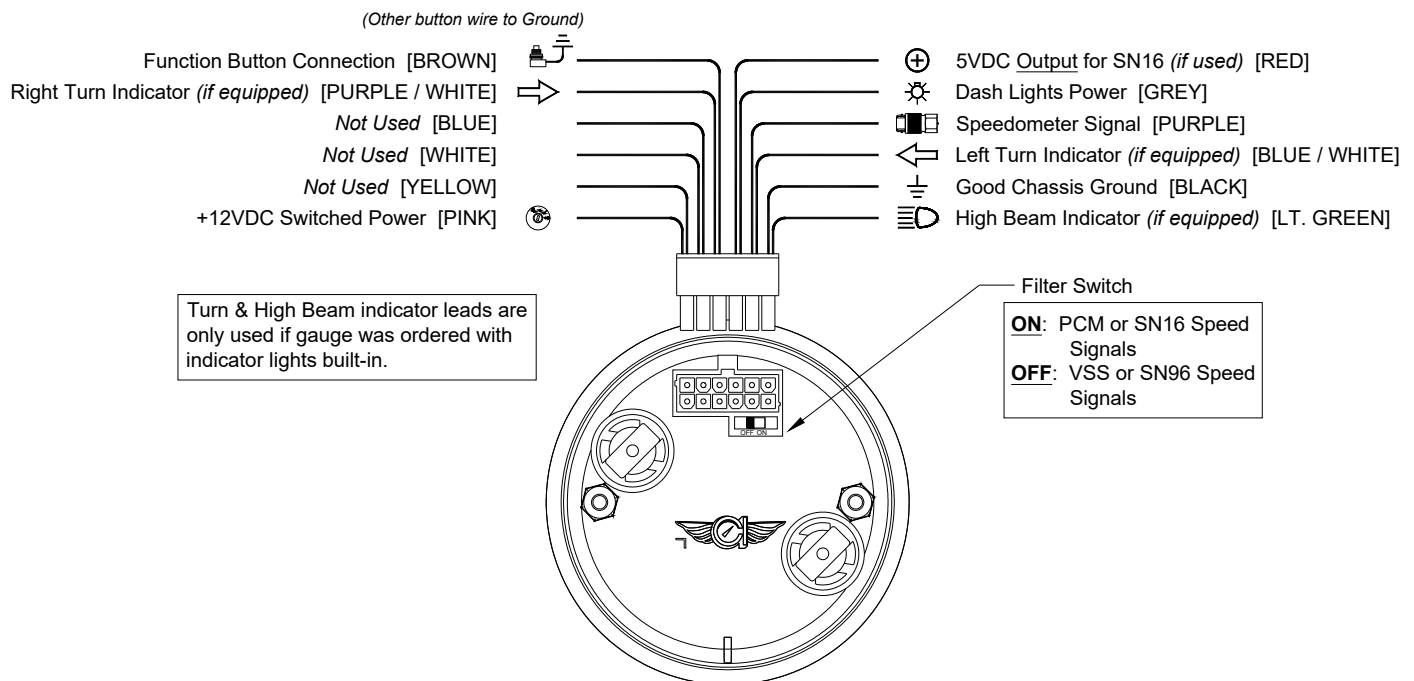

## 4 5/8" Speedometer

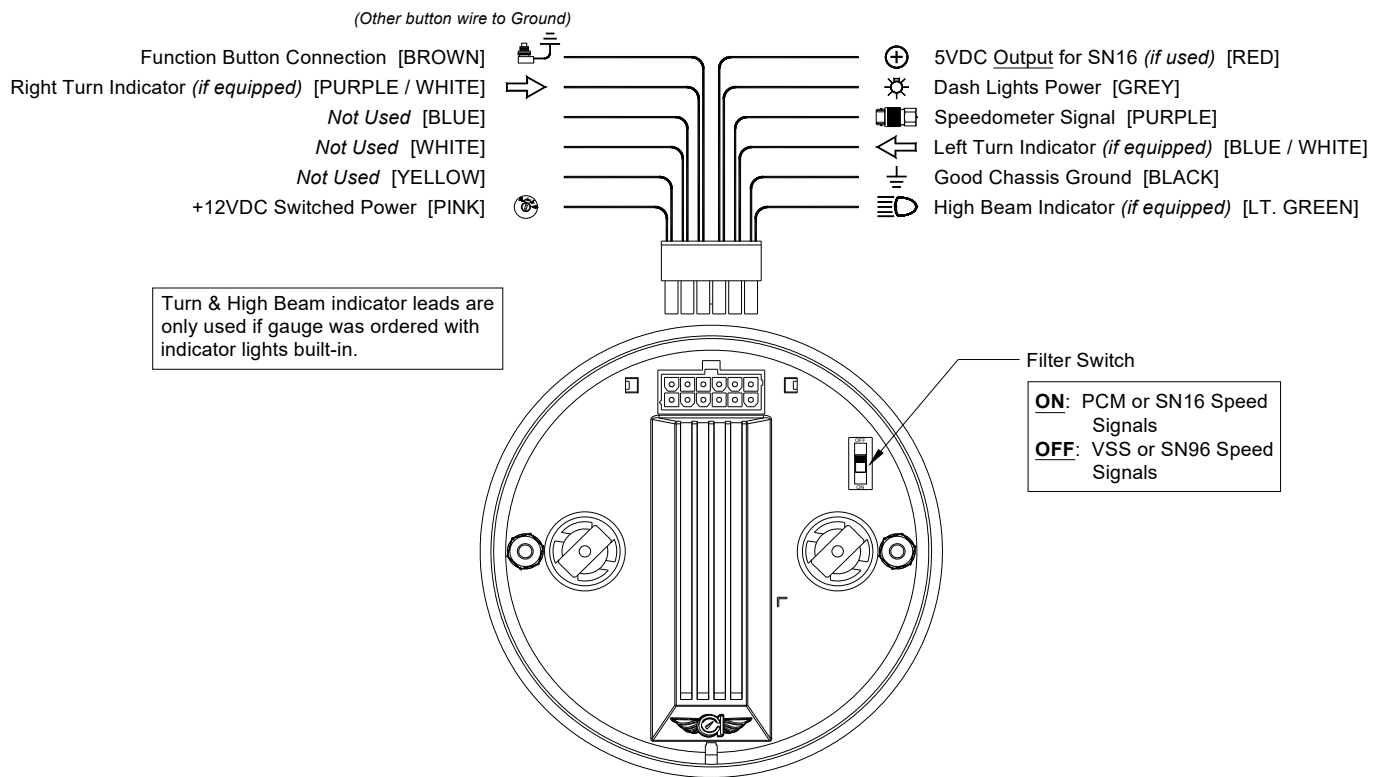

## Speedometer Calibration

**Note:** Before performing speedometer calibration, insure you have a good speed signal. Take a test drive and make sure the speedometer shows a speed (even though it may not be correct)! If the speedometer doesn't show a speed, troubleshoot the speed signal before attempting to calibrate the speedometer.

Only one calibration method is necessary to perform to calibrate the speedometer. Pick the method that works best for you.

- The "Instant" calibration method requires a GPS reference speed signal (or pace car). You will need to drive at 30mph. This method is convenient if the speedometer is more than 10mph off at a known 60mph.
- The "Real-time" calibration method requires a GPS reference speed signal (or pace car). This method allows you to drive at any known speed and make changes to the speedometer reading as you go. This method is best used if the speedometer calibration is less than 10mph off at a known 60mph.
- The "Measured Mile" calibration method requires you to drive a known mile. This is convenient when a GPS is not available to use as a reference and also if the calibration is off more than 10mph at a known 60mph. The speed at which you drive the known mile can be varied, a GPS reference or pace car is not necessary.

## Speedometer Calibration Modes

Speedometer Indication		Calibration Mode
50 MPH	Set Speed Instant	Speedometer "Instant" Calibration
60 MPH	Set Speed Real Time	Speedometer "Real-time" Calibration
70 MPH	Set Speed Marked MI	Speedometer "Measured Mile" Calibration
80 MPH	Set Defaults	Factory Defaults Reset Mode
90 MPH	Exit	Exit Calibration Mode
100 MPH	View Settings	View Current Calibration Settings

### ***Entering Calibration Mode:***

- 1) Start with power to the gauge OFF.
  - 2) Press and HOLD the function pushbutton.
  - 3) While holding the pushbutton, start engine.
  - 4) After the engine is started, Release the pushbutton. The speedometer pointer will do a full sweep and the information screen will read "**Entered Setup Mode**". The speedometer pointer will then immediately move to indicate 50MPH and the information screen will read "**Set Speed Instant**".
-

Set Speed  
Instant

## Speedometer “Instant” Calibration:

(steps 1-4 may be skipped if the gauge is already in calibration mode)

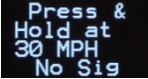
- 1) Start with power to the gauge OFF.
  - 2) Press and HOLD the function pushbutton.
  - 3) While holding the pushbutton, start engine.
  - 4) Release the pushbutton after the engine is started. The speedometer will do a full sweep and the information screen will read “**Entered Setup Mode**”.
  - 5) After a few seconds, the information screen will read “**Set Speed Instant**” while the speedometer will indicate 50MPH. *If the speedometer is not showing 50MPH and “Set Speed Instant”, continue to tap the button to cycle through the calibration modes until it comes back to this option.*
  - 6) Press and hold the function pushbutton until the speedometer changes to 0 MPH and the
- information screen reads
- 
- 7) Drive the vehicle at exactly 30MPH using a GPS or pace car as a reference. The bottom of the information screen will show “**No Sig**” if a speed signal is not detected or flash “**Sig**” if one is detected.
  - 8) Press and hold the pushbutton while traveling 30MPH for approximately 4 seconds until the speedometer moves up to 30MPH. The speedometer will now track your speed and the information screen will read “**Saved Instant**”. Verify that the speedometer is reading accurately.
  - 9) Tap the pushbutton to get back to the calibration mode options.
  - 10) Tap the pushbutton (as many times as needed) to move through the calibration modes until you get

Exit

to the 90MPH (Exit Calibration Mode) option. Press and hold the button for about 6 seconds until the information screen shows your speed or odometer and the speedometer starts indicating your actual speed. The speedometer calibration is now saved.

Set Speed  
Real Time

## Speedometer “Real-Time” Calibration:

(steps 1-4 may be skipped if the gauge is already in calibration mode)

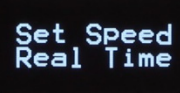
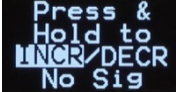
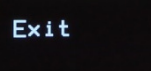
- 1) Start with power to the gauge OFF.
- 2) Press and HOLD the function pushbutton.
- 3) While holding the pushbutton, start engine.
- 4) Release the pushbutton after the engine is started. The speedometer will do a full sweep and the information screen will read “**Entered Setup Mode**”.
- 5) After a few seconds, the information screen will read “**Set Speed Instant**” while the speedometer remains at 50MPH.
- 6) Tap the function pushbutton once to change the information screen to  and move the speedometer pointer up to 60MPH. *If the speedometer is not showing 60MPH and “Set Speed Real Time”, continue to tap the button to cycle through the calibration modes until it comes back to this option.*
- 7) Press and hold the function pushbutton until the speedometer changes to 0 MPH and the information screen shows .
- 8) Begin driving a known speed using a GPS or pace vehicle as a reference. The bottom of the information screen will show “**No Sig**” if a speed signal is not detected or flash “**Sig**” if one is detected.
- 9) Press and hold the pushbutton to slowly change the indicated speed. The first time the button is pressed and held will increase the speedometer reading and “**INCR**” will be highlighted on the information screen. The next time the button is pressed and held will decrease the speedometer reading and “**DECR**” will be highlighted on the information screen. The speedometer will continue to alternate between increasing and decreasing speed each time the button is pressed and held.
- 10) Continue to press and hold the pushbutton to adjust the speedometer until it is indicating the correct speed.
- 11) Once the correct speed is dialed in on the speedometer, wait approximately 30 seconds without pressing the pushbutton to have the current calibration saved. The Information screen will momentarily show “**Saved Real Time**” to indicate successful calibration and then display your current speed.
- 11) Tap the pushbutton (as many times as needed) to move through the calibration modes until you get to the 90MPH (Exit Calibration Mode) option.  Press and hold the button for about 6 seconds until the information screen shows your speed or odometer and the speedometer starts indicating your actual speed. The speedometer calibration is now saved.

Set Speed  
Marked MI

## Speedometer “Measured Mile” Calibration:

(steps 1-4 may be skipped if the gauge is already in calibration mode)

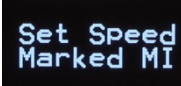
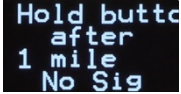
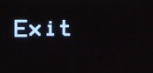
- 1) Start with power to the gauge OFF.
- 2) Press and HOLD the function pushbutton.
- 3) While holding the pushbutton, start engine.
- 4) Release the pushbutton after the engine is started. The speedometer will do a full sweep and the information screen will read “**Entered Setup Mode**”.
- 5) After a few seconds, the information screen will read “**Set Speed Instant**” while the speedometer remains at 50MPH.
- 6) Tap the function pushbutton twice to change the information screen to  and move the speedometer pointer up to 70MPH. *If the speedometer is not showing 70MPH and “Set Speed Marked MI”, continue to tap the button to cycle through the calibration modes until it comes back to this option.*
- 7) Press and hold the function pushbutton until the speedometer changes to 30 MPH and the information screen momentarily shows “**Begin Driving**” and then changes to .
- 8) Begin driving a known measured mile. *The speed at which you drive the mile does not matter.* The bottom of the information screen will show “**No Sig**” if a speed signal is not detected or flash “**Sig**” if one is detected.
- 9) At the end of the mile, press and hold the pushbutton until the speedometer moves from 30MPH up to 90MPH and the information screen reads “**Saved Marked MI**”. *To get a more accurate calibration, stop at the end of the mile.*
- 10) Press and hold the button (with the speedometer still indicating 90MPH) for about 6 seconds until the information screen shows the speed or odometer and the speedometer starts indicating your actual speed. The speedometer calibration is now saved.
  - a. If the speedometer is not indicating 90MPH, tap the pushbutton (as many times as needed) to move through the calibration modes until you get to the 90MPH (Exit Calibration Mode)  option. Press and hold the button for about 6 seconds until the information screen shows the odometer and the speedometer starts indicating your actual speed. The speedometer calibration is now saved.

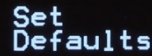
A black rectangular button with the text "Set Defaults" in white, stacked vertically.

## **Reset Gauge Calibration to Factory Defaults:**

*(steps 1-4 may be skipped if the gauge is already in calibration mode)*

- 1) Start with power to the gauge OFF.
- 2) Press and HOLD the function pushbutton.
- 3) While holding the pushbutton, start engine *(or just turn the key ON)*.
- 4) Release the pushbutton after the engine is started (or the key is ON). The speedometer will do a full sweep and the information screen will read **“Entered Setup Mode”**.
- 5) After a few seconds, the information screen will read **“Set Speed Instant”** while the speedometer remains at 50MPH.

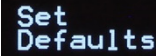
A black rectangular button with the text "Set Defaults" in white, stacked vertically.

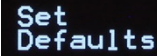
- 6) Tap the pushbutton three times to change the information screen to  and move the speedometer pointer up to 80MPH. *If the speedometer is not showing 80MPH and “Set Defaults”, continue to tap the button to cycle through the calibration modes until it comes back to this option.*
- 7) With the speedometer indicating 80MPH, press and hold the function pushbutton until the information screen shows **“Saved Defaults”** and the speedometer changes to 90 MPH. The factory speedometer calibration (16,000ppm) is now set.
- 8) With the speedometer pointer at 90MPH, press and hold the button for about 6 seconds until the speedometer pointer moves down to zero and the information screen displays the odometer or speed.



View  
Settings

## View Current Speedometer Calibration Settings:

*(steps 1-4 may be skipped if the gauge is already in calibration mode)*

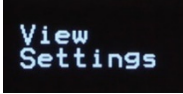
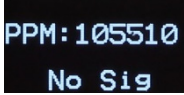
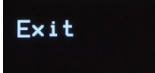
- 1) Start with power to the gauge OFF.
- 2) Press and HOLD the function pushbutton.
- 3) While holding the pushbutton, start engine *(or just turn the key ON)*.
- 4) Release the pushbutton after the engine is started (or the key is ON). The speedometer will do a full sweep and the information screen will read **“Entered Setup Mode”**.
- 5) After a few seconds, the information screen will read **“Set Speed Instant”** while the speedometer remains at 50MPH.
- 6) Tap the pushbutton five times to change the information screen to  and move the speedometer pointer up to 100MPH. *If the speedometer is not showing 100MPH and “View Settings”, continue to tap the button to cycle through the calibration modes until it comes back to this option.*
- 7) With the speedometer indicating 100MPH, press and hold the pushbutton until the information screen shows the pulses per mile (ppm) calibration setting of the speedometer.  The speedometer will also move to show your current speed and the bottom of the information screen will show **“No Sig”** if a speed signal is not detected or flash **“Sig”** if one is detected.
- 8) When you are done viewing the calibration settings, tap the pushbutton. The information screen will show **“Set Speed Instant”** and the pointer will move to 50MPH.
- 9) Tap the pushbutton (as many times as needed) to move through the calibration modes until you get to the 90MPH (Exit Calibration Mode) option.  Press and hold the button for about 6 seconds until the information screen shows your speed or odometer and the speedometer starts indicating your actual speed.